

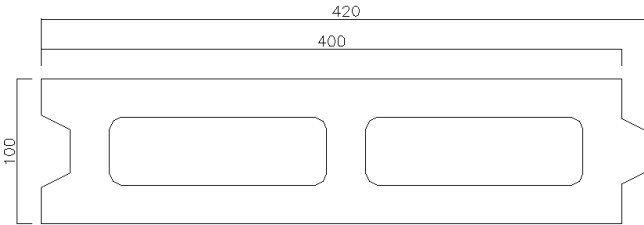

ISO
9001:2008
REGISTERED

BR35

BRIKET 10 x 40

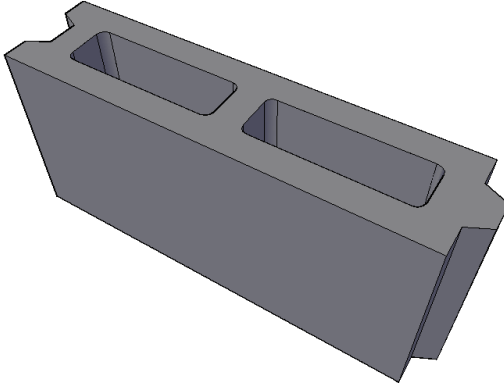

BETONSEN MAK. METAL ÜRÜN. İML. İTH. İHR. SAN. VE TİC. LTD. ŞTİ.

1231 sk. NO: 8-10 OSTİM / YENİMAHALE / ANKARA / TÜRKİYE TEL: 0090 312 386 34 82-83 info@betonsen.com