

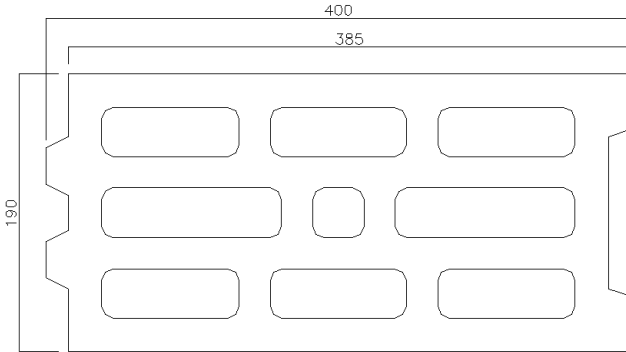

ISO  
9001:2008  
REGISTERED

**BR46**

**BRIKET 19 x 40**

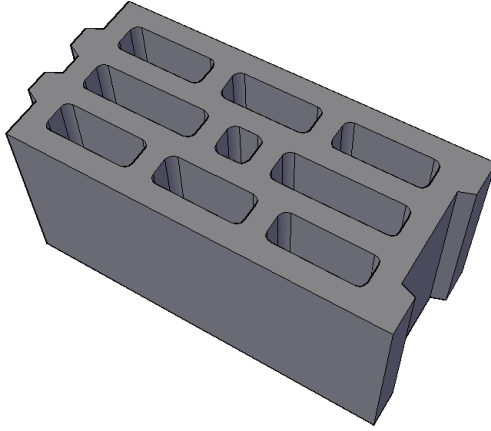

**BETONSEN MAK. METAL ÜRÜN. İML. İTH. İHR. SAN. VE TİC. LTD. ŞTİ.**

1231 sk. NO: 8-10 OSTİM / YENİMAHALE / ANKARA / TÜRKİYE TEL: 0090 312 386 34 82-83 [info@betonsen.com](mailto:info@betonsen.com)